

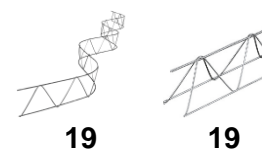

PRODUCTOS

**TU COLABORADOR
EN ACCESORIOS
PARA LA CONSTRUCCIÓN
Y/O REHABILITACIÓN**

SEPARADORES

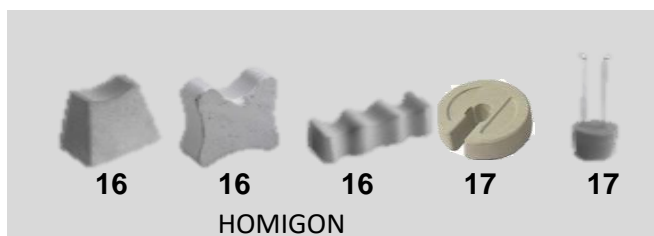
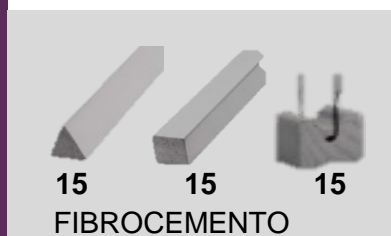

ENCOFRADOS Y ACCESORIOS

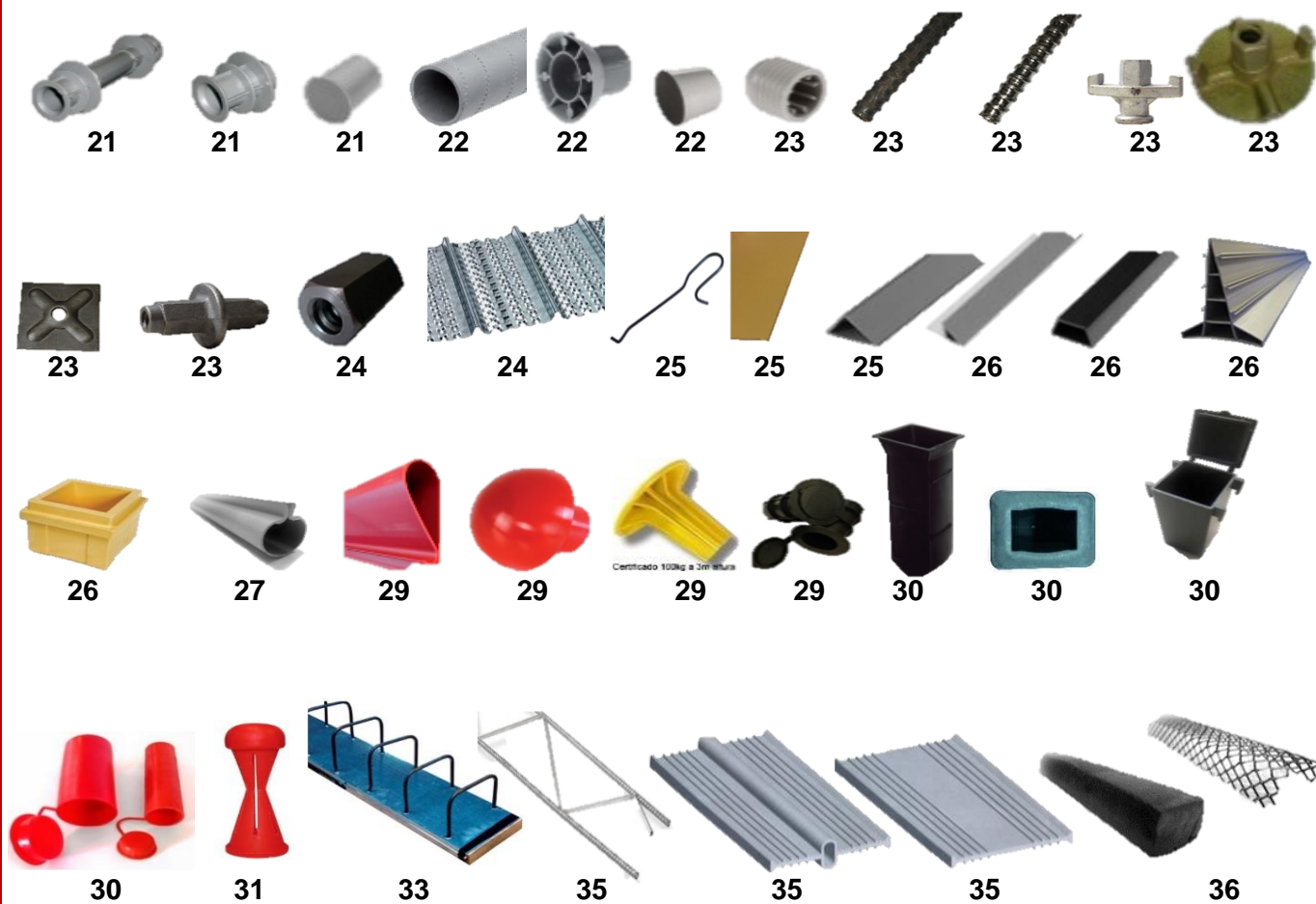

IMPERMEABILIZACION
Y DRENAJE



38

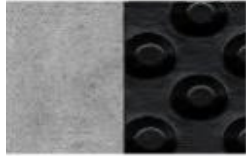

38



39



38-39



41



41



41



42



42



42

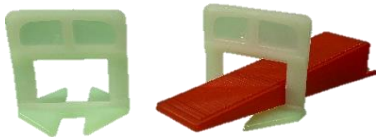

44



45

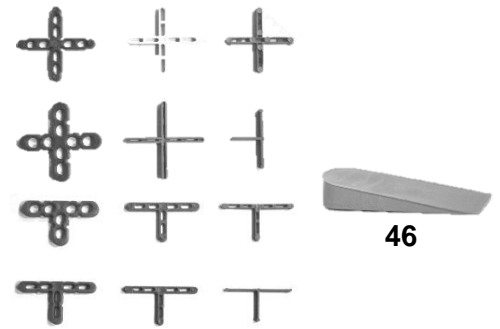

45-46

46



46



46

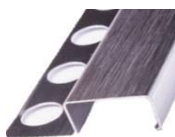

47



47



47



47



48



48



48



48



48



49



49

PAREDES Y SUELOS



Separadores de Plástico

Drunterleiste, barra de refuerzo

Referencia	Recubrimien to mm	Longitud m	m / Paquete	m / Palet
DL15/200	15	2	100	6600
DL20/200	20	2	100	6300
DL25/200	25	2	100	4900
DL30/200	30	2	100	4200
DL35/200	35	2	60	3600
DL40/200	40	2	60	2400
DL45/200	45	2	60	1440
DL50/200	50	2	60	1680
DL60/200	60	2	40	1200
DL70/200	70	2	40	1120



Drupak

Referencia	Recubrimien to mm	Longitud m	m / Paquete	m / Palet
DP...15/200	15	2	100	6000
DP...20/200	20	2	100	6000
DP...25/200	25	2	100	5400
DP...30/200	30	2	100	5400

Espaciador extra fuerte con gran área de soporte para refuerzo horizontal. Hecho de 100% PE reciclado de alta calidad. Muy buen flujo de hormigón gracias a las grandes aberturas laterales y superiores. Adecuado para hormigón visto y techos prefabricados.

NOVEDAD



Drupak2

Referencia	Recubrimien to mm	Longitud m	m / Paquete	m / Palet
DPF35/200..2	35	2	60	3120
DPF40/200..2	40	2	60	2880
DPF45/200..2	45	2	60	2400
DPF50/200..2	50	2	60	2400

Espaciador extra fuerte con gran área de soporte para refuerzo horizontal. Hecho de 100% PE reciclado de alta calidad. Muy buen flujo de hormigón gracias a las grandes aberturas laterales y superiores. Adecuado para hormigón visto y techos prefabricados.

NOVEDAD



Referencia	Recubrimiento mm	Longitud m	m / Paquete	m / Palet
DUW15/80	15	0,8	70	4410
DUW20/80	20	0,8	60	3780
DUW25/80	25	0,8	40	2800
DUW30/80	30	0,8	40	2520
DUW35/80	35	0,8	30	2100
DUW40/80	40	0,8	30	1890
DUW50/80	50	0,8	20	1540

Espaciador extra fuerte con alta estabilidad utilizado para el refuerzo inferior. Tiene un muy buen flujo de hormigón debido a su forma en zigzag y a los pies alternados. Gracias a su diseño especial, los palets apilables! Por lo tanto, un ahorro óptimo de los costes de transporte y un uso perfecto del espacio de almacenamiento.

NOVEDAD



DRUSPITZ-PLUS

Referencia	Recubrimiento mm	Longitud m	m / Paquete	m / Palet
DUPL15/100	15	1	40	3520
DUPL20/100	20	1	40	3520
DUPL25/100	25	1	40	3520
DUPL30/100	30	1	40	3200
DUPL35/100	35	1	40	3200
DUPL40/100	40	1	40	3200
DUPL45/100	45	1	40	3200
DUPL50/100	50	1	40	3200

Separadores para armaduras ligeras con muy buen flujo de hormigón. Puntas de pie especiales que minimizan el contacto con el encofrado. Las puntas verticales en la parte superior evitan que el refuerzo se deslice. Se puede suministrar sin puntas en la parte superior. Puede aumentar su longitud mediante el sistema de acoplamiento enchufable.

NOVEDAD



DRUFILA-PLUS

Referencia	Recubrimiento mm	Longitud m	m / Paquete	m / Palet
DUFPL20/100	20	1	80	3840
DUFPL25/100	25	1	80	3520
DUFPL30/100	30	1	80	3200
DUFPL35/100	35	1	80	2880
DUFPL40/100	40	1	80	2560
DUFPL50/100	50	1	48	1920
DUFPL60/100	60	1	40	1600

Separadores para armaduras ligeras con muy buen flujo de hormigón. Puntas de pie especiales que minimizan el contacto con el encofrado.

NOVEDAD



2A2PREF Rapi2.

Referencia	Recubrimiento mm	Longitud m	m / Paquete	m / Palet
R210020	20	1	50	5750
R210025	25	1	50	4750
R210030	30	1	50	4000
R210035	35	1	50	3000
R210040	40	1	50	3000
R210045	45	1	50	2250
R210050	50	1	50	2250

NOVEDAD



Unoclip

Referencia	Recubrimiento mm	Para hierro Ø mm	Uds / caja	Uds / Octabin	Uds / Palett
SCO15/6	15	6	4000	-	60000
SCO15/6-8	15	08-jun	4000	-	60000
SCO20/6	20	6	2300	25000	34500
SCO20/6-8	20	08-jun	1500	25000	34500
SCO25/6	25	6	1500	18000	22500
SCO25/6-8	25	08-jun	1300	18000	22500
SCO30/6-8	30	08-jun	1300	13500	19500
SCO30/8-10	30	10-ago	1300	13500	19500
SCO35/6	35	6	1000	-	15000
SCO35/6-8	35	08-jun	1000	-	15000

NOVEDAD



Razzo (separador para muro doble)

Referencia	Recubrimiento mm	Espesor pared mm	Hierro Ø mm	Uds / caja	Uds / Palett
RAZ08/120	15-35	120	8	150	3000
RAZ08/150	15-35	150	8	150	3000
RAZ08/180	15-35	180	8	150	3000
RAZ08/200	15-35	200	8	150	3000
RAZ08/240	15-35	240	8	150	3000
RAZ08/250	15-35	250	8	150	3000
RAZ08/300	15-35	300	8	150	3000
RAZ08/350	15-35	350	8	100	2000
RAZ08/365	15-35	365	8	100	2000
RAZ08/400	15-35	400	8	100	2000
RAZ08/500	15-35	500	8	100	2000
RAZ10/150	15-35	150	10	150	3000
RAZ10/180	15-35	180	10	150	3000
RAZ10/200	15-35	200	10	150	3000
RAZ10/240	15-35	240	10	150	3000
RAZ10/250	15-35	250	10	150	3000
RAZ10/300	15-35	300	10	150	3000
RAZ10/350	15-35	350	10	100	2000
RAZ10/365	15-35	365	10	100	2000
RAZ10/400	15-35	400	10	100	2000
RAZ10/500	15-35	500	10	100	2000



Razzo "2" (separador para muro doble)

Referencia	Recubrimiento mm	Espesor pared mm	Hierro Ø mm	Uds / caja	Uds / Palett
RAZ08/200B2	20-35	200	8	300	6000
RAZ08/240B2	20-35	240	8	250	5000
RAZ08/250B2	20-35	250	8	250	5000
RAZ08/300B2	20-35	300	8	200	4000
RAZ08/360B2	20-35	360	8	200	4000
RAZ08/400B2	20-35	400	8	200	4000
RAZ10/200B2	20-35	200	10	300	6000
RAZ10/240B2	20-35	240	10	250	5000
RAZ10/250B2	20-35	250	10	250	5000
RAZ10/300B2	20-35	300	10	200	4000
RAZ10/360B2	20-35	360	10	200	4000
RAZ10/400B2	20-35	400	10	200	4000

NOVEDAD



Razzo-Pro con núcleos de acero (para muro doble)

Referencia	Recubrimiento mm	Espesor pared mm	Uds / paquete	Uds / Palett
RAZP/180S	15-50	180	54	2430
RAZP/200S	15-50	200	54	2430
RAZP/240S	15-50	240	85	2720
RAZP/250S	15-50	250	85	2720
RAZP/300S	15-50	300	85	1530
RAZP/350S	15-50	350	-	420
RAZP/400S	15-50	400	-	420



Druntreck "pie redondeado", revestimiento rectangular de cuña (individual)

Referencia	Recubrimiento mm	dimensión mm	Uds / paquete	Uds / Palett
DER15	15	95x200	120	8640
DER20	20	95x200	120	8640
DER25	25	95x200	120	8640
DER30	30	95x200	120	8640
DER35	35	95x200	120	8640
DER40	40	95x200	120	8640
DER45	45	95x200	120	8640
DER50	50	95x200	120	8640



Montageplatte, placa de montaje macizo

Referencia	Recubrimiento mm	dimensión mm	Uds / Bolsa	Uds / Saco	Uds / Palett
UP02	2	70x70	250	1000	30000
UP03	3	70x70	250	1000	30000
UP04	4	70x70	125	500	25000
UP05	5	70x70	125	500	25000
UP06	6	70x70	125	500	25000
UP07	7	70x70	125	500	15000
UP08	8	70x70	125	250	12000
UP09	9	70x70	125	250	12000
UP10	10	70x70	125	250	10000
UP12	12	70x70	125	250	8000
UP15	15	70x70	50	250	8000
UP20	20	70x70	50	250	6000

NOVEDAD

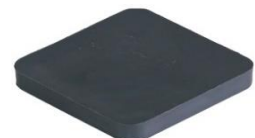

Montageplatte, placa de montaje ligero

Referencia	Recubrimiento mm	dimensión mm	Uds / Bolsa	Uds / Saco	Uds / Palett
UP09N	9	70x70	125	250	12000
UP10N	10	70x70	125	250	10000
UP15N	15	70x70	50	250	8000
UP20N	20	70x70	50	250	6000



Montageplatte, placa de montaje herradura

Referencia	Recubrimiento mm	dimensión mm	Uds / Bolsa	Uds / Saco
UPS02	2	70x70	1000	30000
UPS03	3	70x70	1000	30000
UPS05	5	70x70	500	25000
UPS07	7	70x70	500	15000
UPS09	9	70x70	250	12000
UPS10	10	70x70	250	10000
UPS15	15	70x70	200	8000
UPS20	10	70x70	150	6000



2A2PREF Calzo Mont, placa de montaje

Referencia	Recubrimiento mm	dimensión mm	Uds / Bolsa	Uds / caja
PMOM02	2	95 X 170 mm	400	19200
PMOM03	3	95 X 170 mm	300	14400
PMOM05	5	95 X 170 mm	200	9600
PMOM10	10	95 X 170 mm	100	5700

NOVEDAD



2A2PREF Calzo Super Mont, placa de montaje

Referencia	Recubrimiento mm	dimensión mm	Uds / Bolsa	Uds / caja
PSMOM02	2	170 X 190 mm	200	9600
PSMOM03	3	170 X 190 mm	150	7200
PSMOM05	5	170 X 190 mm	100	4800
PSMOM10	10	170 X 190 mm	50	2850

NOVEDAD



2A2PREF Placa MAGNUM 205X205X40, placa de montaje

Referencia	dimensión mm	Uds / caja
PPM40	205x205x40	780

NOVEDAD

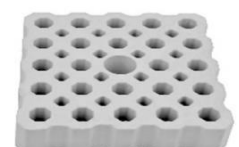

2A2PREF Calzo 30x170, placa de montaje

Referencia	Recubrimiento mm	dimensión mm	Uds / Bolsa	Uds / caja
PSA02	2	30 X 70 mm	1000	20000
PSA03	3	30 X 70 mm	500	20000
PSA05	5	30 X 70 mm	500	18000
PSA10	10	30 X 70 mm	250	8750

NOVEDAD



Stapelplatte, separador alveolar.

Referencia	Tipo	Material	dimensión mm	Uds / Bolsa	Uds / caja	Uds / Palett
USP1	1	TPS "blando"	62 / 160 / 10	200	-	on request
USP2	2	TPS "blando"	62 / 160 / 10	200	-	on request
USP3	3	TPS "blando"	62 / 80 / 10	500	-	on request
USP5	5	TPS "blando"	63 / 250 / 10	-	150	on request
USP1	1	HDPE "duro"	62 / 160 / 10	200	-	on request
USP2	2	HDPE "duro"	62 / 160 / 10	200	-	on request
USP3	3	HDPE "duro"	62 / 80 / 10	500	-	on request
USP4	4	HDPE "duro"	62 / 80 / 10	200	-	on request
USP5	5	HDPE "duro"	62 / 250 / 10	-	150	on request



TIPO 1

TIPO 2

TIPO 3

TIPO 4

TIPO 5

Kunststoffkeil, Cuña de plástico

Referencia	a mm	b mm	c mm	Uds / Bolsa	Uds / Palett
KK70/30	70	30	10	500	25000
KK110/40	110	40	20	250	14000



Hohldielendeckel, tapa de losa hueca

Referencia	Hueco de losa mm	Uds / Palett
HO160/200	160 und 200	3850
HO265/320	265 und 320	1760
HO400/450	400 und 450	1250
HO450/500	450 und 500	1250



Ringabstandhalter, separador anular

Referencia	Recubrimiento mm	Para hierro Ø mm	Uds / Bolsa	Uds / Saco	Uds / Palett
R20	20	4-12 mm	1000	5000	30000
R25	25	4-12 mm	500	2500	30000
R30	30	4-12 mm	500	2000	20000
R35	35	4-12 mm	200	-	12000
R40-ECO	40	6-16 mm	125	500	10000
R40	40	4-12 mm	125	-	10000
R50-ECO	50	6-16 mm	100	300	7800
R50	50	4-12 mm	100	-	5000
R70IT/10-22	70	10-22mm	150	-	6500

* OTRAS MEDIDAS Y DISEÑOS CONSULTAR.



Ringabstandhalter - Piling, separador anular, especial para "Muro Pantalla"

Referencia	Recubrimiento mm	Para hierro Ø mm	Uds / Bolsa	Uds / Palett
R50GB	50	6-20 mm	45	4500
R75GB	75	6-20 mm	45	2205

NOVEDAD



Abstandhalter, separador horizontal

Referencia	Recubrimiento mm	Para hierro Ø mm	Uds / Bolsa	Uds / Saco	Uds / Palett
H15	15	4-16 mm	1000	6000	36000
H20	20	4-16 mm	500	4000	36000
H25	25	4-16 mm	500	3500	21000
H30	30	4-16 mm	250	2500	20000
H35	35	4-16 mm	250	1500	18000
H40	40	4-16 mm	250	1250	15000
H45	45	4-16 mm	125	1000	10000
H50	50	4-16 mm	125	1000	10000



Abstandhalter - 4-Fuß, separador horizontal de 4 pies

Referencia	Recubrimien to mm	Para hierro Ø mm	Uds / Bolsa	Uds / Saco	Uds / Palett
ATV...20	20	6-20 mm	500	2000	12000
ATV...25	25	6-20 mm	500	1500	12000
ATV...30	30	6-20 mm	250	1500	12000
ATV...35	35	6-20 mm	250	1000	10000
ATV...40	40	6-20 mm	250	1000	10000
ATV...50	50	6-20 mm	125	500	7500



T-Omega; separador horizontal, separador horizontal.

Referencia	Recubrimien to mm	Para hierro Ø mm	Uds / Bolsa	Uds / Saco	Uds / Palett
T-OMEGA30	30	6-18 mm	250	1000	30000

* OTRAS MEDIDAS CONSULTAR.





Separadores de Hormigón y Fibrocemento

Flächenabstandhalter (Dreikant voll), "triangular completo" FIBROCEMENTO

Referencia	Recubrimiento mm	Longitud m	Uds / Palett
FBD2510	25	1	1000
FBD3010	30	1	750
FBD4010	40	1	400
FBD5010	50	1	250

* OTRAS MEDIDAS CONSULTAR.



Flächenabstanhalter (Vierkant), "cuadrado" FIBROCEMENTO

Referencia	Recubrimiento mm	Longitud m	Uds / Palett
FBV3010	30	1	500
FBV4010	40	1	250
FBV5010	50	1	200

* OTRAS MEDIDAS CONSULTAR.



Einzelabstandhalter (Knochen), "hueso con alambre" FIBROCEMENTO

Referencia	Recubrimiento mm	Ancho de corte mm	Uds / caja	Uds / Palett
FBEKD35	35-40-50	25	250	10000

* OTRAS MEDIDAS CONSULTAR.



Gießbeton Einzelabstandhalter "Block", sep. horizontal

Referencia	Recubrimien to mm	Uds / Saco	Uds / Palett
GBEB20S	20	700	35000
GBEB25S	25	400	20000
GBEB30S	30	300	15000
GBEB35S	35	250	10000
GBEB40S	40	200	8000
GBEB50S	50	150	6750
GBEB60S	60	125	5000
GBEB70S	70	100	4000



Gießbeton Einzelabstandhalter, hueso sin alambre

Referencia	Recubrimien to mm	Uds / Saco	Uds / Palett
GBEK20S	20X25X30	700	28000
GBEK35S	35X40X50	200	10000
GBEK45S	45X55X60	125	5000



Gießbeton Einzelabstandhalter "Welle", ondulado

Referencia	Longitud mm	Uds / Saco	Uds / Palett
GBEW120S	120	100	6000



Gießbetonrolle, rollo de hormigón

Referencia	Recubrimien to mm	Uds / Saco	Uds / Palett
GBRL35S	35	100	4000
GBRL70S	70	-	475
GBRL75S	75	-	240



Gießbeton Einzelabstandhalter, con alambre

Referencia	Recubrimien to mm	Uds / Saco	Uds / Palett
GBEO20S	20	500	20000
GBEO25S	25	400	20000
GBEO30S	30	300	13500
GBEO40S	40	250	10000
GBEO50S	50	200	8000
GBEO60S	60	125	5000



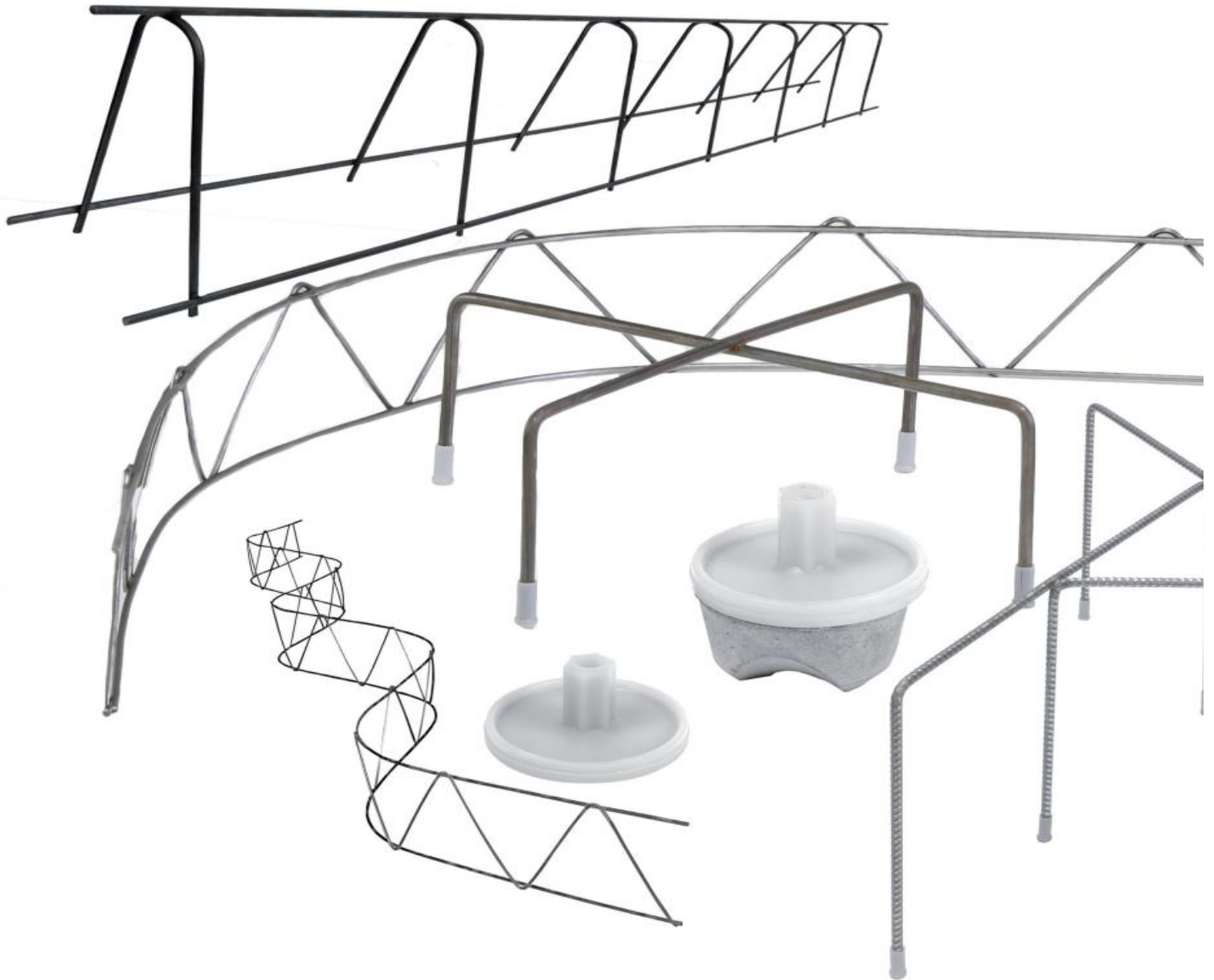

Separadores Metálicos

Referencia	Longitud m	Altura mm	m / Palet	Uds / paquete	Uds / Palett
SMI20R	2	20	7200	25	3600
SMI30RN	2	30	7200	25	3600
SMI40RN	2	40	7200	25	3600
SMI50RN	2	50	2400	25	1200
SMI60RN	2	60	2400	25	1200
SMI70RN	2	70	2400	25	1200
SMI80RN	2	80	2000	25	1000
SMI90RN	2	90	2000	25	1000
SMI100RN	2	100	2000	25	1000
SMI110RN	2	110	1600	25	800
SMI120RN	2	120	1600	25	800
SMI130RN	2	130	1600	25	800
SMI140RN	2	140	1200	25	600
SMI150RN	2	150	1200	25	600
SMI160RN	2	160	1200	25	600
SMI180RN	2	180	1200	25	600
SMI200RN	2	200	800	25	400
SMI220BVN	2	220	800	25	400
SMI240BVN	2	240	800	25	400
SMI260BVN	2	260	800	25	200
SMI280BVN	2	280	800	25	150
SMI300BVN	2	300	450	25	150
SMI320BV	2	320	450	25	150
SMI340BV	2	340	300	25	150
SMI360BV	2	360	300	25	150
SMI380BV	2	380	300	25	150
SMI400BVN	2	400	300	25	150



Unterstützungskorb, armazón de apoyo A

Referencia	Longitud m	Altura mm	Ancho mm	Uds / paquete
SMIA50	2	50	75	250
SMIA60N	2	60	75	250
SMIA70	2	70	75	250
SMIA75	2	75	75	250
SMIA80N	2	80	75	250
SMIA90N	2	90	75	250
SMIA100N	2	100	75	250
SMIA105	2	105	75	250
SMIA110N	2	110	75	250
SMIA120N	2	120	75	250
SMIA130N	2	130	75	250
SMIA135	2	135	75	250
SMIA140N	2	140	75	250
SMIA150N	2	150	75	250
SMIA155	2	155	85	250
SMIA160N	2	160	85	250
SMIA170N	2	170	85	250
SMIA180N	2	180	85	250
SMIA190N	2	190	85	250
SMIA200N	2	200	85	250

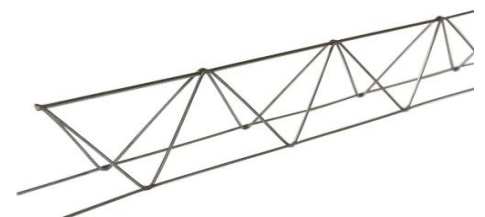



Accesorios de Encofrado

Referencia	Espesor pared mm	Uds / Bolsa	Uds / Palett
*OD15	150	100	2400
O175/3T	175	100	2400
*OD18	180	100	2400
*OD20	200	100	2400
OD22/3T	220	100	2400
*OD24	240	100	2400
*OD25	250	100	2400
*OD30	300	100	2400
*OD35	350	100	1500
OD36/3T	360	100	1500
*OD365	365	100	1500
*OD40	400	100	1500
OD45/3T	450	50	800
OD50/3T	500	50	800
OD55/3T	550	50	800
OD60/3T	600	50	800



DISTANZ-cono

Referencia	Para Ø tubo mm	Uds / Saco	Uds / Palett
ODK	22/26	200	5000



DISTANZ-tapón

Referencia	Uds / Saco	Uds / Palett
OS	200	25000



Abstandsrohr, tubo distanciador, Sup. Picada

Referencia	Ø interior mm	Ø Exterior mm	Longitud m	m / Paquete	m / Palet
A1419/2	14	19	2	100	3000
A2024/2	20	24	2	100	3000
A2026/2	20	26	2	100	3000
A2225/2	22	25	2	100	3500
A2226/2	22	26	2	100	3000
A2228/2	22	28	2	100	3000
A2630/3	26	30	2	50	2100
A2631/3	26	31	2	50	2100
A2632/3	26	32	2	50	2100
A3036/3	30	36	2	50	1500
A3236/3	32	36	2	50	1500



Konen, cono

Referencia	Para Ø tubo mm	Long.montaje mm	Uds / Bolsa	Uds / Palett
K20	20	10	500	24000
K22	22	10	500	30000
K26	26	10	250	28000
K32	32	10	250	5000



Stopfen, tapón

Referencia	Para Ø tubo mm	Uds / Bolsa	Uds / Palett
ST20	20	1000	48000
ST22	22	1000	48000
ST26	26	1000	50000
ST32	32	500	24000



Dichtstopfen, tapón obturador

Referencia	Para Ø tubo mm	Uds / Bolsa	Uds / Saco	Uds / Palett
DS22	22	500	2500	50000



Gewindestahl, barra de acero roscado DISCONTINUA

Referencia	Tipo mm	Longitud m	carga perm.Kn	kg / m	Uds / Bolsa
GWS15/2/100	15/17	1	90	1,44	100



Gewindestahl, barra de acero roscado CONTINUA

Referencia	Tipo mm	Longitud m	Uds / paquete
GWS15/1ECO	15/17	1	10

NOVEDAD



Flügelmutter, tuerca de mariposa

Referencia	Tipo mm	Material	kg / uds	Uds / Bolsa
GWS15/FL	15/17	galvanizado	0,3	50



Tellermutter, tuerca de plato

Referencia	Tipo mm	Material	Ø mm	kg / uds	Uds / Bolsa
GWS15/TM-ECO	15/17	galvanizado	90mm	0,4	50
GWS15/TM	15/17	galvanizado	100mm	0,46	50



Ankerplatte, placa de anclaje

Referencia	Tipo mm	Material	kg / uds	Uds / Bolsa
GWS15/AP	15/17	negro	0,46	50



Wassersperre, cierre de agua

Referencia	Tipo mm	Material	kg / uds	Uds / Bolsa
GWS15/WS	15/17	negro	0,52	50



Sechskantmutter, tuerca hexagonal

Referencia	Tipo mm	Material	Longitud mm	kg / uds	Uds / Bolsa
GWS15/SK	15/17	negro	50	0,22	100



Verbindungsmuffe, manguito de conexión

Referencia	Tipo mm	Material	Longitud mm	kg / uds	Uds / Bolsa
GWS15/VM	15/17	galvanizado	100	0,46	50



Encofrado perdido ENCOFRA2

Referencia	Tipo mm	espesor mm	m ² / Paquete	m ² / Palet	Uds / paquete	Uds / Palett
ENC2504005	2500X400	0,5	10	500	10	500
ENC2505005	2500X500	0,5	12,5	625	10	500
ENC2506005	2500X600	0,5	15	750	10	500
ENC2507005	2500X700	0,5	17,5	875	10	500

Encofra2 es una lámina de acero cincado cortado y estirado que permite la supervisión durante el vertido del hormigón, soporta una velocidad de hormigonado de 4-7 m³/h, facilita la unión de la armadura y el hormigón en un solo boque y es compatible con hormigón autonivelante.

NOVEDAD



Federstahlbinder, unión de acero de resorte

Referencia	Tipo mm	Ø mm	Acero 1 Ø mm	Acero 2 Ø mm	Uds / caja	Uds / Palett
FST5/5	05-may	1,45	4 - 5 mm	4 - 5 mm	14000	168000
FST5/7	07-may	1,45	4 - 5 mm	6 - 7 mm	10000	150000
FST5/8	08-may	1,45	4 - 5 mm	6 - 8 mm	10000	150000
FST5/10	10-may	1,60	4 - 5 mm	8 - 10 mm	10000	150000
FST5/12	12-may	1,60	4 - 5 mm	10 - 12 mm	8000	120000
FST5/16	16-may	1,80	4 - 5 mm	14 - 16 mm	6000	72000
FST5/20	20-may	1,90	4 - 5 mm	18 - 20 mm	4000	48000
FST6/6	06-jun	1,45	4 - 6 mm	4 - 6 mm	18000	216000
*FST6/8	08-jun	1,45	4 - 6 mm	6 - 8 mm	15000	180000
*FST8/8	08-ago	1,50	6 - 8 mm	6 - 8 mm	10000	120000
*FST8/10	10-ago	1,50	6 - 8 mm	8 - 10 mm	13000	156000
FST8/10-12	10/08/2012	1,80	6 - 8 mm	8-10-12 mm	8000	96000
*FST8/12	12-ago	1,60	6 - 8 mm	10 - 12 mm	10000	120000
*FST8/14	14-ago	1,60	6 - 8 mm	12 - 14 mm	10000	120000
*FST8/16	16-ago	1,70	6 - 8 mm	14 - 16 mm	8000	96000
FST8/18	18-ago	1,85	6 - 8 mm	16 - 18 mm	5600	67200
*FST8/20	20-ago	1,85	6 - 8 mm	18 - 20 mm	5600	67200
FST8/22	22-ago	1,90	6 - 8 mm	20 - 22 mm	4000	48000
FST8/24	24-ago	1,90	6 - 8 mm	22 - 24 mm	5600	67200
FST10/20-22	20/10/2022	2,00	8 - 10 mm	18 - 20 - 22 mm	4000	48000
FST12/12	12-dic	1,80	10 - 12 mm	10 - 12 mm	7200	86400
FST12/14-16	14/12/2016	2,00	10 - 12 mm	12 - 14 - 16 mm	4000	48000
FST12/22	22-dic	2,00	10 - 12 mm	20 - 22 mm	4000	48000
FST12/24	24-dic	2,00	10 - 12 mm	22 - 24 mm	3000	45000
FST16/16	16 / 16	1,90	14 - 16 mm	14 - 16 mm	6000	72000



Panel 2aHV, panel para homigón Visto.

Referencia	Longitud mm	Ancho m	espesor mm	m ² / Palet	kg / Palet	Uds / Palett
2AHV3210122	2100	1220	3	737,86	2335,615932	288



Dreikantleiste, Berenjeno "sin brida de clavado"

Referencia	a mm	b mm	Longitud m	m / Paquete	m / Palet
D10	10	15	2,5	100	10000
D15	15	21	2,5	100	10000
D20	20	28	2,5	100	10000
D25	25	35	2,5	100	4900
D30	30	41	2,5	100	4900



*** OTRAS MEDIDAS CONSULTAR.**

2Asocia2; C/ Vial Parc, 12, 03330 Crevillente (Alicante) – ESPAÑA.

Teléfono: 865 601 892 E-mail: comercial@2asocia2.com

Dreikantleiste, Berenjeno "con brida de clavado"

Referencia	a mm	b mm	c mm	Longitud m	m / Paquete	m / Palet
DFH10	10	15	24	2,5	100	10000
DFH15	15	21	31	2,5	99	9900
DFH20	20	28	36	2,5	100	5000
DFH25	25	35	45	2,5	50	2450
DFH30	30	41	53	2,5	50	1800

* OTRAS MEDIDAS CONSULTAR.

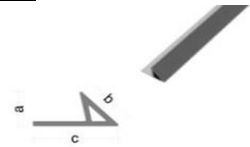

Trapezprofil, perfil trapezoidal

Referencia	a mm	b mm	c mm	Longitud m	m / Paquete	m / Palet
T20	20	10	10	2,5	100	2000

* OTRAS MEDIDAS CONSULTAR.

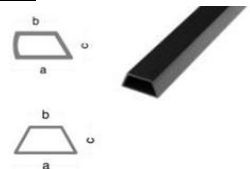

2A2JD Junta de Dilatación para forjados.

Referencia	Tipo	Longitud m	m / Paquete	m / Palet	Color
2A2JD08	80	2,5	50	600	Gris
2A2JD04	40	2,5	100	1200	Gris

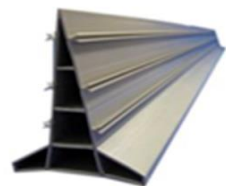

Cubo de ensallos de PU

Referencia	Tipo mm	Uds / Saco	Uds / Palett
2A2CUB15X15	15X15	20	120

NOVEDAD



Vaina para corrugado

Referencia	Tipo	Longitud m	m / Paquete	m / Palet
VA2A38	3/8"	3	150	-
VA2A05	0,5"	3	150	24000
VA2A06	0,6"	3	150	15000

NOVEDAD





Accesorios Seguridad y Encofrados

NEVOSAFE, perfil de protección, para varillas en línea.

Referencia	Longitud m	Para hierro Ø mm	Uds / paquete	Uds / Palett
SP/100	1	8-40 mm	6	294
SPS/100	1	8-40 mm	6	294



Schutzkappe, Tapa protectora

Referencia	Para hierro Ø mm	Uds / Bolsa	Uds / Palett
SKA6/18	6-18 mm	250	10000
SKA16/32	16-32 mm	250	5000



Nevosafe®-plus Schutzkappe; con nucleo de acero

Referencia	Para hierro Ø mm	Uds / caja	Uds / Palett
SKAS6/20	6-20 mm	40	1280
SKAS20/36	20-36 mm	30	960



Certificado 100kg a 3m altura

Base Guardacuerpos "Protec"

Referencia	Para Ø mm	Uds / Bolsa	Uds / Palett
BGC40	40 mm	200	6000



Base para horca "Redtec"; 60x60

Referencia	Dimension mm	Uds / caja	Uds / Palett
BH6060	60x60	45	1350



Base para horca "Redtec"; 60x40

Referencia	Dimension mm	Uds / caja	Uds / Palett
BH6040	60x40	114	2736

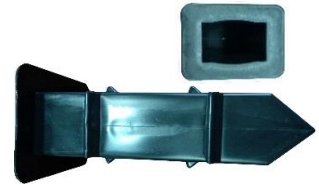

2A2SEG Base anclaje Cuadrada 45 x45 x 120mm.

Referencia	dimensión mm	Uds / Saco	Uds / Palett
BAC4545120	45x45x120	100	4500

NOVEDAD



2A2SEG Base anclaje Redonda.

Referencia	Para Ø mm	Longitud mm	Uds / Saco	Uds / Palett
BAR26115	26mm	115mm	100	15600
BAR42115	42mm	115mm	50	7200

NOVEDAD



2A2SEG Protector RA.

Referencia	Uds / Saco	Uds / Palett
PRA0614	250	76500
PRA1020	150	25200
PRA1632	50	12600
PRA1633200	200	12600

NOVEDAD



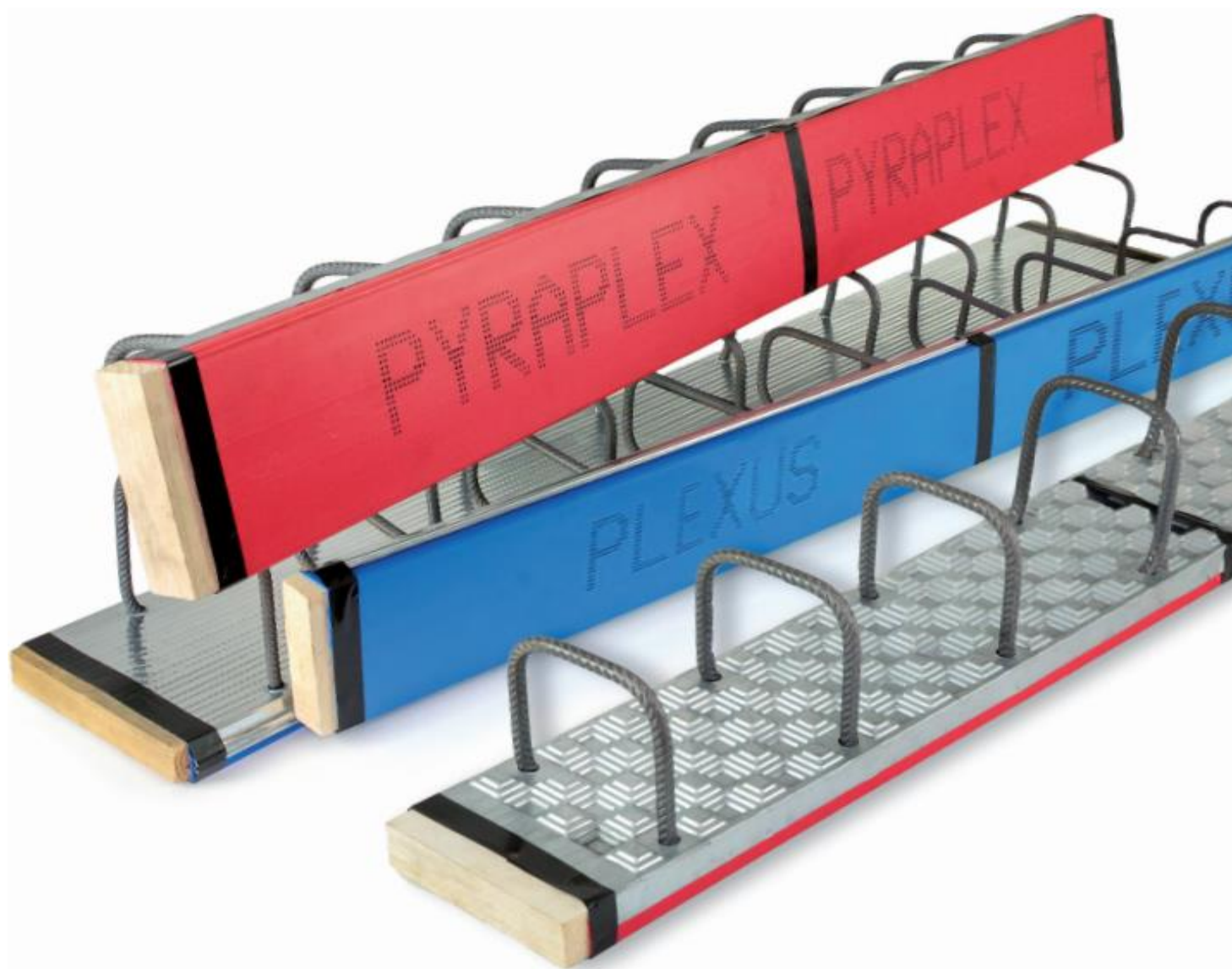

Sistemas de Refuerzo y Juntas de Estanqueidad

Plexus Bügelleisten, (ancho arco 9 cm, ancho caja 11,5 cm)

Referencia	Espesor pared mm	Hierro Ø mm	Dist. entre arcos mm	m / Paquete	m / Palet
BK081009..	160-180	8	100	7,5	120
BK081509..	160-180	8	150	7,5	120
BK082009..	160-180	8	200	7,5	120
BK082509..	160-180	8	250	7,5	120
BK101009..	160-180	10	100	7,5	120
BK101509..	160-180	10	150	7,5	120
BK102009..	160-180	10	200	7,5	120
BK102509..	160-180	10	250	7,5	120
B121009..	160-180	12	100	7,5	120
BK121509..	160-180	12	150	7,5	120
BK122009..	160-180	12	200	7,5	120
BK122509..	160-180	12	250	7,5	120



Plexus Bügelleisten, (ancho de arco 12 cm, ancho de caja 14,5 cm)

Referencia	Espesor pared mm	Hierro Ø mm	Dist. entre arcos mm	m / Paquete	m / Palet
BK081012..	180-200	8	100	5	100
BK081512..	180-200	8	150	5	100
BK082012..	180-200	8	200	5	100
BK082512..	180-200	8	250	5	100
BK101012..	180-200	10	100	5	100
BK101512..	180-200	10	150	5	100
BK102012..	180-200	10	200	5	100
BK102512..	180-200	10	250	5	100
BK121012..	180-200	12	100	5	100
BK121512..	180-200	12	150	5	100
BK122012..	180-200	12	200	5	100
BK122512..	180-200	12	250	5	100



Plexus Bügelleisten, (ancho de arco 15cm, ancho de caja 17,5cm)

Referencia	Espesor pared mm	Hierro Ø mm	Dist. entre arcos mm	m / Paquete	m / Palet
BK081015..	200-240	8	100	5	100
BK081515..	200-240	8	150	5	100
BK082015..	200-240	8	200	5	100
BK082515..	200-240	8	250	5	100
BK101015..	200-240	10	100	5	100
BK101515..	200-240	10	150	5	100
BK102015..	200-240	10	200	5	100
BK102515..	200-240	10	250	5	100
BK121015..	200-240	12	100	5	100
BK121515..	200-240	12	150	5	100
BK122015..	200-240	12	200	5	100
BK122515..	200-240	12	250	5	100



Plexus Bügelleisten, (ancho de arco 20cm, ancho de caja 22,5cm)

Referencia	Espesor pared mm	Hierro Ø mm	Dist. entre arcos mm	m / Paquete	m / Palet
B081020..	270-290	8	100	5	80
B081520..	270-290	8	150	5	80
B082020..	270-290	8	200	5	80
B082520..	270-290	8	250	5	80
B101020..	270-290	10	100	5	80
B101520..	270-290	10	150	5	80
B102020..	270-290	10	200	5	80
B102520..	270-290	10	250	5	80
B121020..	270-290	12	100	5	80
B121520..	270-290	12	150	5	80
B122020..	270-290	12	200	5	80
B122520..	270-290	12	250	5	80



1. ANCLAMOS A ENCOFRADO



2. UNA VEZ SACADOS LOS ENCOFRADOS QUITAMOS LAS TAPAS PROTECTORAS

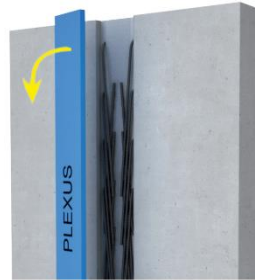

3. DESPLEGAMOS LOS NEGATIVOS

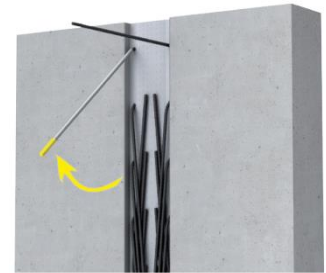

4. UNIMOS LOS NEGATIVOS A LA NUEVA FERRALLA5. ENCOFRAMOS Y HORMIGONAMOS

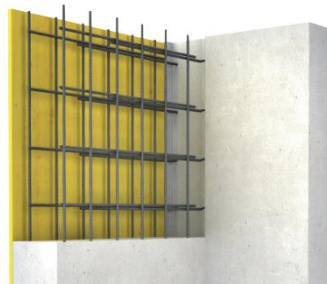
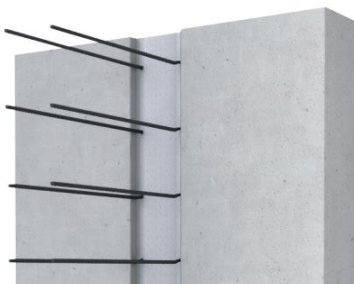

6. YA TENEMOS NUESTRO MURO PERPENDICULAR.



*** OTRAS MEDIDAS Y DISEÑOS CONSULTAR.**

2A2GriFur Refuerzo para muros.

Referencia	Tipo mm	Longitud m	Medida palet cm	Uds / paquete	Uds / Palett
SFVZRH50/4	4 / 3,7 / 4	3,05	305x60x33	20	600
GSFVZRH80/5	5 / 3,7 / 5	3,05	305x60x45	20	480
SFVZRH100/4	4 / 3,7 / 4	3,05	305x57x49	20	600
SFVZRH150/4	4 / 3,7 / 4	3,05	305x57x46	20	400
SFVZRH200/4	4 / 3,7 / 4	3,05	305x56x33	20	200



2A2GriFur es una armadura de muro prefabricada en acero galvanizado que consta de dos partes alambres longitudinales paralelos, que están soldados a un alambre diagonal continuo. Debido a su carácter único la forma y la calidad de los alambres, el refuerzo 2A2GriFur mejora la resistencia del muro y previene grietas que podrían producirse por contracción, movimiento o vibración.

NOVEDAD

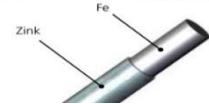

2A2EST WATERSTOP - BULBO, junta de estanqueidad.

Referencia	Tipo mm	Longitud m	Rollos / palet	m / Palet
PWSB150	150	25	15	375
PWSB200	200	25	15	375
PWSB220	220	25	15	375
PWSB250	250	25	15	375
PWSB300	300	25	15	375

El WaterStop -Bulbo es una junta de estanqueidad hidráulica que además tiene una alta capacidad de absorción a los empujes mecánicos.

Se utiliza entre las juntas entre pantallas, losas, muros estancos para cualquier tipo de agua.

NOVEDAD



2A2EST WATERSTOP, junta de estanqueidad.

Referencia	Tipo mm	Longitud m	Rollos / palet	m / Palet
PLAESTWS150	150	25	15	375
PLAESTWS200	200	25	15	375
PLAESTWS220	220	25	15	375
PLAESTWS250	250	25	15	375
PLAESTWS300	300	25	15	375

NOVEDAD

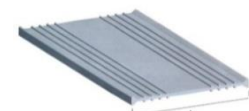

2A2EST Junta de Bentonita y red para la junta, estanqueidad.

Referencia	Tipo mm	Material	Longitud m	Rollos / palet	m / Palet
PGBEN25	25x20	bentonita	30	36	1080
PRETGBEN	25x20	red de armado	30	36	1080
PGBEN15	15x20	bentonita	36	36	1296
PRETGBEN20X15	15x20	red de armado	36	36	1296

La bentonita es una Junta de estanqueidad hidroexpansiva (aumenta con la humedad y rellena los huecos y grietas).

Se utiliza para el sellado entre cimentación y muro de carga, en juntas de hormigonado, pilares, etc.

NOVEDAD





Laminas Drenantes, desolidarización e impermeabilización.

Lamina Drenante 2A2 - Standard

Referencia	Ancho m	Longitud m	Rollos / palet	m ² / Palet	palets / trailer
LD400/2/30	2	30	12	720	32



Lamina Drenante 2A2 PLUS con Geotextil

Referencia	Ancho m	Longitud m	Rollos / palet	m ² / Palet	palets / trailer
LDG400/2/20	2	20	6	240	32



Lámina Impermeabilización 2a2

Referencia	Ancho m	Longitud m	Rollos / palet	m ² / Palet	palets / trailer
LI02/1/30	1	30	30	900	68

NOVEDAD

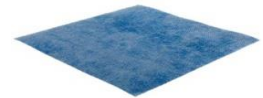

Accesorio Esquina Interior

Referencia	Tipo	a mm	b mm	c mm
LIESINT25	Esq. interior	120	120	90

NOVEDAD

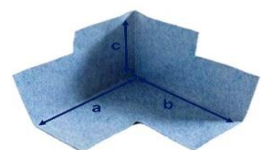

Accesorio Esquina Exterior

Referencia	Tipo	a mm	b mm	c mm
LIESEXT25	Esq. exterior	110	110	90

NOVEDAD

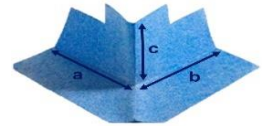

Accesorio Cubre Tubos

Referencia	Tipo	a mm	b mm
LICABLE25	Pasador tubo	120	120

NOVEDAD

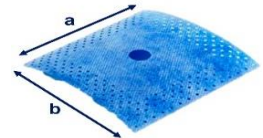

Accesorio Banda Perimetral

Referencia	Tipo	a mm	Longitud m
LIBAN125/30	Cinta perimetral	125	30

NOVEDAD



2A2DES Lamina DESOLIDARIZACION - 2A2

Referencia	Ancho m	Longitud m	Rollos / palet	m ² / Palet	palets / trailer
0	1,15	26,2	12	361,56	40

NOVEDAD

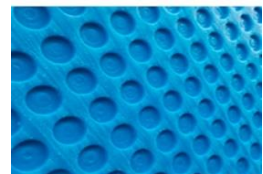



ARIETE hormigón Aligerado.

**Protección contra el fuego
PROTHERM LIGHT**

**Aislamiento acústico GUM GUM
Spray.**

**Gama para Saneamiento y
deshumidificación.**



Codigo	Producto	Packaging	Rendimiento m ² /cm	Cantidad por pallet	Medidas pallet
02001070FIT00	ARIETE 250 F	Saco 70 Litros	7	40 Sacos (Vol: 2,8 m ³)	120x120 cm Peso: 720 Kg Altura: 195 cm

Uso:

- Solera ligera y termo-aislantes (con o sin formación de pendiente).
- Morteros de disminución y relleno.
- Aislamiento térmico en cubiertas (con vertientes inclinadas, planas con o sin formación de pendiente). Indicado para la colocación directa de los mantos de impermeabilización prefabricados (bituminosos en caliente, bituminosos en frío, sintéticos en frío) o envolturas líquidas sin disolventes.



PROTHERM LIGHT revoques ligeros para la PROTECCION CONTRA EL FUEGO

Codigo	Producto	Packaging	Rendimiento Kg m ² /cm	Cantidad por pallet	Medidas pallet
03003316GITIP	Protherm Light Gris	Saco 18 Kg	3	40 sacos (Vol: 2,8 m ³)	120x120 cm Peso: 740 Kg Altura: 185 cm
03003316BITIP	Protherm Light Blanco	Saco 18 Kg	3	40 sacos (Vol: 2,8 m ³)	120x120 cm Peso: 740 Kg Altura: 185 cm

Uso:

- Sistema de protección contra incendios, específico para mejorar la resistencia al fuego de elementos estructurales de acero, ladrillo, hormigón armado normal y pretensado y en edificios de uso civil e industrial.
- Aplicación mecánica.
- Para uso en interiores y exteriores.



GUM GUM Spray capa de insonorización y aislamiento acústico.

Codigo	Producto	Packaging	Cantidad por pallet	Medidas pallet
1800GGSGUMGU M	Gum Gum Spray	Cubo 8 Kg + Botella de 5 l	27 cubos con tanque incluido	120x120 cm Peso: 351 Kg Altura: 105 cm

Uso:

- Capa elástica para la reducción del ruido de impacto en sistemas de insonorización de soleras flotantes, especialmente indicado para la realización de soleras flotantes de espesor reducido, incluso en presencia de sistemas sin capa de nivelación.
- Reducción del ruido de impacto en las escaleras.
- Capa de insonorización para aplicar en el hueco de tabiques dobles verticales en ladrillo y en paredes en de ladrillo y cemento.
- Realización de capas de separación de sub-pared o revestimiento de puentes acústicos en general tales como pilares y vigas de hormigón.
- Tratamiento de aislamiento acústico de patios interiores para el paso de instalaciones, tuberías de descarga individuales fabricadas en PVC o similar.





TECOSEL gama de Saneamiento y Deshumidificación.

Página 41

Codigo	Producto	Packaging	Rendimiento m ² / kg	Cantidad por pallet	Medidas pallet
04002004NIT00	Tecosel	Tanque 4 Kg	5	30 Tanques	80x120 cm Peso: 140 Kg Altura: 60 cm

Uso:

- Tratamiento pluri-componente en base solvente, para la inhibición de las eflorescencias salinas.



DRYMUR gama de Saneamiento y Deshumidificación.

Codigo	Producto	Packaging	Rendimiento m ² /2 cm	Cantidad por pallet	Medidas pallet
04001001NIT00	Drymur	Caja 10 envases de 1 Kg cad.	8	10 cajas	80x120 cm Peso: 100 Kg Altura: 60 cm

Uso:

- Aditivo líquido para la preparación de morteros macroporosos deshumidificadores de elevada permeabilidad.



EDILSTIK Latex e inertizantes.

Codigo	Producto	Packaging	Rendimiento m ² / kg	Cantidad por pallet	Medidas pallet
04007001NIT00	Edilstik Kg 1	Caja con 10 envases de 1 Kg/cad		10 cajas	80 x 120 cm Peso: 100 Kg Altura: 60 cm
04007005NIT00	Edilstik Kg 5	Tanque 5 Kg		100 tanques	80x120 cm Peso: 520 Kg Altura: 120 cm
04007020NIT00	Edilstik Kg 20	Tanque 20 Kg		27 tanques	80x120 cm Peso: 550 Kg Altura: 120 cm
04007999NNN00	Edilstik Kg 1000	Cisterna 1000 Kg		1 cisterna	100x120 cm Peso: 340 Kg Altura: 115 cm

Uso:

- Latex para mejorar los morteros y favorecer asíla adhesión al plano de colocación.



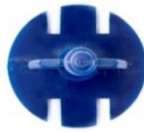

Suelos y paredes

Referencia	Tipo	Tipo mm	Uds / Saco	Uds / caja	Uds / Palett
2A2N031201	Ceram.3-12mm	1	250	3000	108000
2A2N031201,5	Ceram.3-12mm	1,5	250	3000	108000
2A2N031202	Ceram.3-12mm	2	250	3000	108000
2A2N031203	Ceram.3-12mm	3	250	3000	108000
2A2N132402	Cera.13-24mm	1,5	250	3000	108000
2A2N132401,6	Cera.13-24mm	2	250	3000	108000

NOVEDAD



2A2NIVEL Cuña de nivelación para cerámica.

Referencia	Uds / Saco	Uds / caja	Uds / Palett
2A2NCUÑA	250	2000	72000

NOVEDAD



2A2NIVEL Pinza sistema nivelación.

Referencia	Material
2A2NPINPL	plástico
2A2NPINAC	acero

NOVEDAD



2A2BELL sistema de nivelacion para pavimento y revestimiento cerámico, campana.

Referencia	Material	Uds / Saco	Uds / caja	Uds / Palett
2A2BELLTRANS	transparente	50	1000	24000
2A2BELLSEMI	semitransp.	50	1000	24000

NOVEDAD



Referencia	Tipo mm	Uds / Saco	Uds / caja	Uds / Palett
2A2CR1	1	250	3000	75000
2A2CR1,5	1,5	250	3000	75000
2A2CR2	2	250	3000	75000

NOVEDAD



2A2BELL sistema de nivelacion para pavimento y revestimiento cerámico, calzo o base CRUZ.

Referencia	Tipo mm	Uds / Saco	Uds / caja	Uds / Palett
2A2CRCRUZ1	1	250	3000	75000
2A2CRCRUZ1,5	1,5	250	3000	75000

NOVEDAD



2A2BELL sistema de nivelacion para pavimento y revestimiento cerámico, calzo o base T.

Referencia	Tipo mm	Uds / Saco	Uds / caja	Uds / Palett
2A2CRENT1	1	250	3000	75000
2A2CRENT1,5	1,5	250	3000	75000

NOVEDAD



2A2CROSS CRUCETAS, de separación.

Referencia	Tipo mm	Uds / Saco	Uds / caja	Uds / Palett
2A2CROSS01	1	250	22500	945000
2A2CROSS02	1	250	20000	840000
2A2CROSS03	1	250	17000	714000
2A2CROSS04	1	250	12000	504000
2A2CROSS05	1	250	10000	420000
2A2CROSS07	1	250	7500	315000
2A2CROSS10	1	250	5000	210000

NOVEDAD

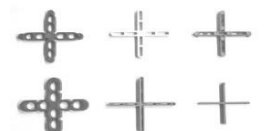

2A2CROSS MEDIA CRUCETA, de separación.

Referencia	Tipo mm	Uds / Saco	Uds / caja	Uds / Palett
2A2MEDIAC02	1	250	30000	1260000
2A2MEDIAC03	1	250	25000	1050000
2A2MEDIAC04	1	250	18000	756000
2A2MEDIAC05	1	250	17000	714000
2A2MEDIAC07	1	250	8500	357000
2A2MEDIAC10	1	250	7500	315000

NOVEDAD



2A2CROSS Cuña de cerámico, para separación.

Referencia	Tipo	Uds / Saco	Uds / caja
2A2CRCUÑA05	CUÑA 0/5	500	20000
2A2CRCUÑA10	CUÑA 5/10	500	10000

NOVEDAD



GUARDACANTOS ALUMINIO PLANO EX

Referencia	Tipo mm	a mm	Longitud m	kg / uds	Uds / caja	Color
2023	abierto	10,5	2,60	319 gr	50 PZAS	Blanco Brillo
2024	abierto	10,5	2,6	319 gr	50 PZAS	Plata Brillo
2030	abierto	10,5	2,6	319 gr	50 PZAS	Plata Mate



GUARDACANTOS ALUMINIO-EX

Referencia	Tipo mm	a mm	Longitud m	kg / uds	Uds / caja	Color
400	abierto	9,5	2,60	320 gr	50 PZAS	Blanco
401	abierto	9,5	2,60	320 gr	50 PZAS	Plata Brillo
404	abierto	9,5	2,60	320 gr	50 PZAS	Plata Mate
402	abierto	9,5	2,60	320 gr	50 PZAS	Oro Brillo
2090	abierto	12,5	2,60	320 gr	50 PZAS	Plata Brillo
2091	abierto	12,5	2,60	320 gr	50 PZAS	Plata Mate
3031	CERRADO	11,5	2,60	320 gr	50 PZAS	Plata Brillo
3030	CERRADO	11,5	2,60	320 gr	50 PZAS	Plata Mate



Referencia	a mm	b mm	Longitud m	kg / uds	Uds / caja	Color
450	12	13	2,60	280 gr	50 PZAS	Plata Brillo
452	12	13	2,60	281 gr	50 PZAS	Plata Mate
460	25	13	2,60	364 gr	50 PZAS	Plata Brillo
462	25	13	2,60	364 gr	50 PZAS	Plata Mate
16051	10	13	2,60	431 gr	50 PZAS	Plata Brillo
16052	10	13	2,60	431 gr	50 PZAS	Plata Mate
456	10	13	2,60	431 gr	50 PZAS	Blanco

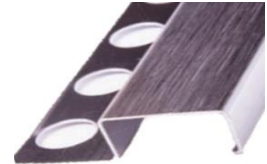

NIVEL 10 X 12 ACERO INOX

Referencia	Material	a mm	b mm	Longitud m	kg / uds	Uds / caja
1954	Acero INOX	12	10	2,60	699 gr	20 PZAS



GUARDACANTOS 12,5 mm ACERO INOX

Referencia	Material	a mm	Longitud m	kg / uds	Uds / caja
1969	Acero INOX	12,5	2,60	699 gr	25 PZAS



PERFIL "U"

Referencia	a mm	b mm	Longitud m	kg / uds	Uds / caja
1961	8	10	2,50	260 gr	25 PZAS
1960	8	15	2,50	372 gr	25 PZAS
1959	8	20	2,50	432 gr	25 PZAS



NIVEL 12 X 12 RUSTICO

Referencia	Material	a mm	b mm	Longitud m	kg / uds	Uds / caja
229	Rustico	12	12	2,6	699 gr	25 PZAS



GUARDACANTOS RUSTICO

Referencia	Material	a mm	Longitud m	kg / uds	Uds / caja
236	Rustico	12,5	2,6	699 gr	25 PZAS



PELDAÑO RUSTICO

Referencia	Material	Longitud m	kg / uds	Uds / caja
363	Rustico	2,6	260 gr	25 PZAS



CANTONERA YESO

Referencia	Longitud m	kg / uds	Uds / caja
5000250	2,50	250 gr	100 PZAS
5000260	2,60	260 gr	100 PZAS



CANTONERA YESO

CANTONERA MONOCAPA PVC

Referencia	Longitud m	kg / uds	Uds / caja
5001	2,50	300 gr	50 PZAS



CANTONERA MONOCAPA

CANT. MONO. PUNTA FINA (TABIQUE)

Referencia	Longitud m	kg / uds	Uds / caja
947	2,50	280 gr	50 PZAS



JUNQUILLO MONOCAPA PVC BLANCO

Referencia	Longitud m	kg / uds	Uds / caja
8021	2,00	120 gr	125 PZAS

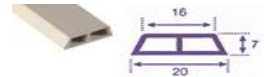

Separadores y accesorios de encofrados



Gama de productos Aislantes térmicos, RF, Saneariento y aislameinto acústico

Area técnica:



Area Comercial:



Area Institucional:





2ASOCIA2-CREVILLENTE-1988, S.L.

C/ Vial Parc, 12,
03330 Crevillente (Alicante) – ESPAÑA.
Teléfono: (+34) 865 601 892
E-mail:comercial@2asocia2.com